

PROJECT: _____
 CATALOG #: _____
 FIXTURE TYPE: _____
 NOTES: _____

PG Parking Garage Gen 1



PERFORMANCE INFORMATION

SERIES NUMBER	WATT	LUMENS	CCT
PG 50 G1 5K	45W	5,000	5000K
PG 50 G1 4K	45W	4,897	4000K
PG 71 G1 5K	60W	7,100	5000K
PG 71 G1 4K	60W	7,021	4000K

The *PG Parking Garage Series* provides high lumen output, greater energy efficiency and more reliable fixture performance. High temperature polycarbonate lens reduces yellowing and directs the light to desired locations. Fully gasketed for weatherproof integrity.

APPLICATIONS

Parking Garages and Walkways, etc.

REPLACEMENT

100W - 175W MH

OPTIONS



MS-FSP-211



L2/L3



EL UNV-8W



PG with Motion Sensor and Emergency Battery Pack

ORDERING GUIDE						EXAMPLE: PG 50 G1 5K W
Luminaire Type	Lumen Output	Generation	Voltage	CCT	Finish	Options
PG Parking Garage	50 5,000 Lumens 71 7,100 Lumens	G1	BLANK= 120-277V	4K 4000K 5K 5000K	W=White	BLANK= No Option MS-FSP-211= Motion Sensor (Choose 1) L2= 360° lens up to 8' mounting height L3= 360° lens 8'-20' mounting height MS-FSIR-100= Wireless commissioning tool EL UNV-8W= Emergency Backup Kit

Due to continuous product improvements, specification and/or equipment updates may change without notice.

SPECIFICATIONS

HOUSING

Sealed die-cast aluminum housing.

AMBIENT TEMPERATURE

Suitable for use in -40°C to $+40^{\circ}\text{C}$ (-40°F to 104°F)

MOUNTING

Surface mounted with J-box or Pendent with conduit

EFFICACY

Up to 118 lumens per watt (see individual wattage data)

CCT AND CRI

4000 and 5000K CCT available; 72CRI

OPTICS

Round drop lens constructed of polycarbonate with refractive design

WARRANTY

10-year limited warranty.

ELECTRICAL

50/60Hz operation with 120-277V input. Optional 0-10V dimming.

ENERGY DATA

Power Factor above 90%.

FINISH

Polyester Powder White finish.

CERTIFICATIONS

UL Listed for wet locations, IP65 Rating. FCC compliant. RoHs compliant. Design Lights Consortium® (DLC) Premium 5.1 qualified product. Not all versions of this product may be DLC qualified. Please visit www.slgus.com to confirm which versions are qualified.

DIMENSIONS

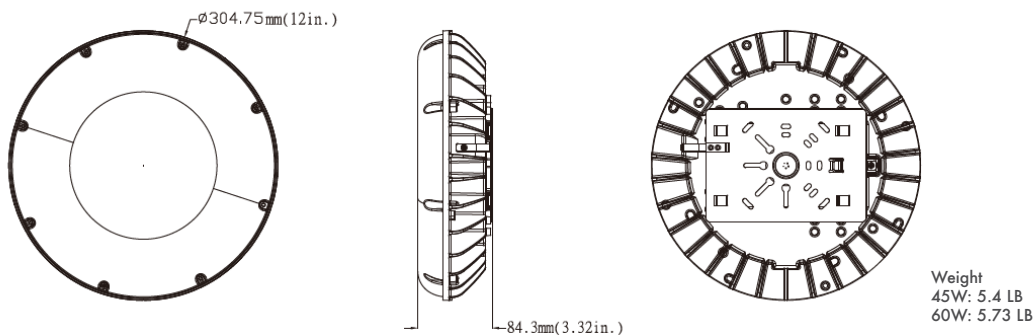

Due to continuous product improvements, specification and/or equipment updates may change without notice.

OPTIONS



MS-FSP-211
Motion Sensor



L2/L3
Lens

The **MS-FSP-211** provides multi-level control over motion and daylight levels. This sensor is IP66 rated when installed inside the fixture. The L2 Lens is designed for mounting heights less than 8 ft whereas the L3 Lens is suitable for mounting heights up to 20 ft in parking garage applications.

Operation Voltage	Shape	Adjustable Time Delay	Fade Down Time	Operating Temperature	MS-FSP-L2 Mounting Height	MS-FSP-L3 Mounting Height
120-277V	Cone	30 sec - 30 min (Default 15min)	0-10 sec	-40°F to 158°F (-40°C to 70°C)	Maximum 8 ft	Maximum 20 ft

*Covers 48 ft diameter when the mounting height is 8 ft. Coverage is equal to 6x the height.

**Covers 40 ft diameter when mounting height is 20 ft. Coverage is equal to 2x the height.

FSP-L2

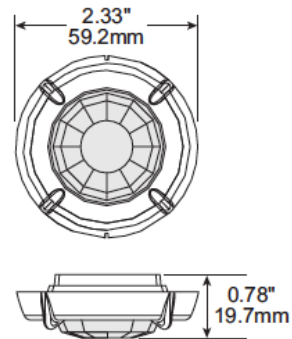
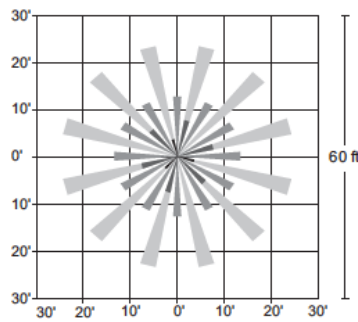
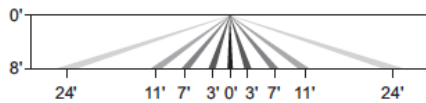

FSP-L3

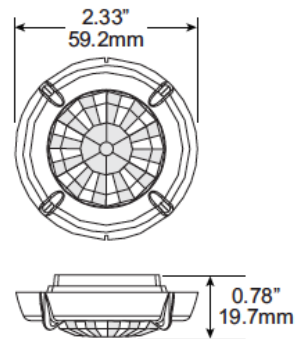
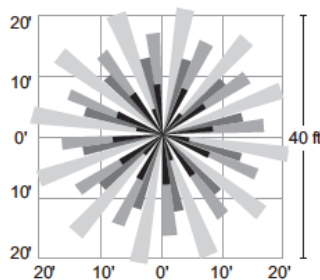
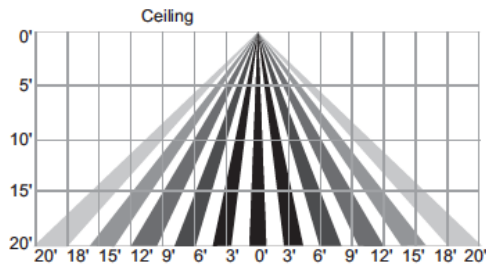

Due to continuous product improvements, specification and/or equipment updates may change without notice.

PHOTOMETRIC

PG 50 G1 5K

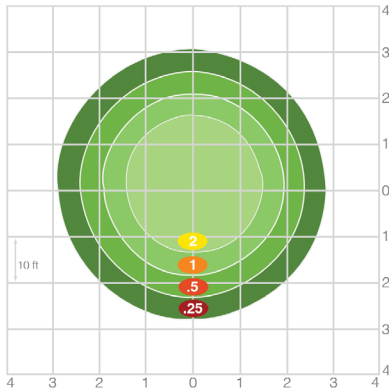

Mounting Height	8	9	10	11	12
Multiplier	1.6	1.2	1.0	0.8	0.7

PERFORMANCE COMPARISON

Series Number	Watt	Lumens	Efficacy	Replaces	Voltage	Mounting Height	DLC
PG 50	45W	5,000	111 Lm/W	100W	120-277V	8-15 ft	Premium
PG 71	60W	7,100	118 Lm/W	175W	120-277V	8-15 ft	Premium

ELECTRICAL LOAD

Series Number	Wattage	Current (A)			
		120V	208V	240V	277V
PG 50 G1 5K	45W	0.38	0.22	0.19	0.16
PG 50 G1 4K	45W	0.38	0.22	0.19	0.16
PG 71 G1 5K	60W	0.50	0.29	0.25	0.22
PG 71 G1 4K	60W	0.50	0.29	0.25	0.22

Due to continuous product improvements, specification and/or equipment updates may change without notice.